





SureFire



iBURNER MANAGEMENT SYSTEMS

INSTALLATION & OPERATIONS MANUAL

Made in USA

BMS-100

Status Codes:

Run Codes:

- 0 System Running
- 1 Purge Before Start up
- 4 5 Second Alarm
- 5 Igniter On

Standby Codes:

- 6 Spare Standby
- 7 Loss of Fuel Gas Standby
- 8 Flame Sense Countdown

For technical support,
contact SureFire @ 505-333-2876
www.SureFire-Controls.com

Shutdown Codes:

- 11 Manual / Remote Shut Off
- 12 Max Retries Exceeded
- 13 Low Battery Volts
- 14 Igniter Disconnected
- 15 Igniter Short
- 16 Shutdown Interlock
- 17 ESD Activated
- 18 Replace FT- Ignition Unit
- 19 T/C Flame Sensor Error or Disconnected
- 20 Solenoid Short
- 21 Solenoid Disconnected
- 22 Safety T/C High Temp. Shutdown
- 23 Safety T/C Error or Disconnected

OFF / Shutdown

Blinking = System in Shutdown - Check Status Code
Solid = System Manually Shutdown

ON / Standby

Blinking = System in Standby - Check Status Code
Solid = System On

PROUDLY MADE IN THE USA

Table of Contents

♦ Table of Contents:	2
♦ Introduction:	3
♦ Certification and Warnings:	4
♦ Warranty and Return Policy:	5 - 6
♦ BMS-100 Description:	7 - 10
♦ SureFire Ignition Units:	11 - 12
♦ SureFire Additional Components:	13 - 14
♦ Installation Guide:	15 - 18
♦ Specifications:	19
♦ Run Status, Alarm Out and Flame Strength:	20
♦ Diagrams:	21-24
♦ BMS-100 Setup / Menu:	25 - 28
♦ Sequence of Operation:	29 - 32
♦ Troubleshooting Guide:	33 - 36
♦ Daughter Board Information:	37
♦ Modbus Information:	38 - 41

BMS-100 System Introduction

The BMS-100 is designed as a pilot maintainer for Flare, Combustor or Fire Tube applications within the Oil and Gas Industry. The BMS-100 is designed to operate with the FT Ignition units to provide optimal ignition.

The controller's display is designed to operate in ambient temperature from -40°F to 131°F , and is coated for corrosion resistance. The unit is mounted in a NEMA 4X enclosure supplied with a UV resistant keypad. Each unit includes function indicator lights and a status code chart printed on the overlay to provide assistance in troubleshooting. The units require 12 VDC power and is solar ready with a specific solar power termination port.

This Burner Management System is suitable for use in
Class 1, Division 2, Groups C and D or unclassified locations.

The BMS-100 monitors a pilot flame utilizing Type K thermocouple. The SureFire controller controls and monitors both the pilot and main burner valves as required. Flame failure shutdowns, alarm functions, high temperature shutdown and other features allow this system to operate as a fail safe system. The SureFire BMS-100 and ignition unit packages provides solutions for environmental and regulatory compliance. Additional option adder cards are available with Modbus communication, data logging, 4-20ma input control and high temperature safety shutdown.

Every SureFire system must pass complete factory QA/QC inspections before shipment.



We are dedicated to providing quality, American-made safety control systems for industrial burners. The system has been developed through thousands of hours of critical design, engineering, and field testing.

Certifications and Warnings

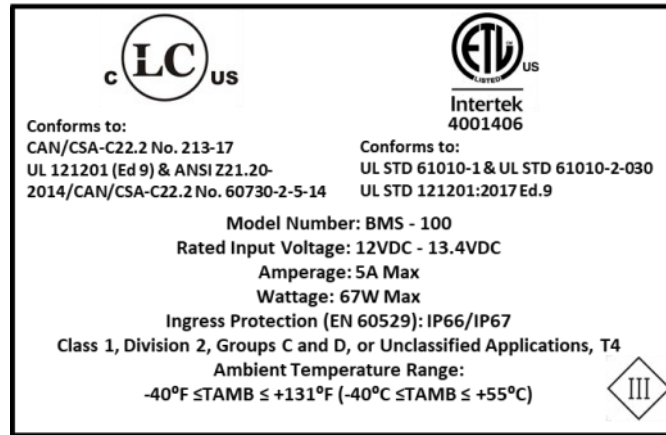

WARNING

EXPLOSION HAZARD - SUBSTITUTION OF COMPONENTS MAY IMPAIR SUITABILITY FOR CLASS I, DIVISION 2, GROUPS C AND D, OR UNCLASSIFIED APPLICATIONS;

MISE EN GARDE

RISQUE D'EXPLOSION - LA SUBSTITUTION DE COMPOSANTS PEUT ALTÉRER APTITUDE POUR LA CLASSE I, DIVISION 2, GROUPES C ET D OU DES APPLICATIONS DE UNCLASSIFIED ;

WARNING

EXPLOSION HAZARD - DO NOT DISCONNECT EQUIPMENT UNLESS POWER HAS BEEN SWITCHED OFF OR THE AREA IS KNOWN TO BE NON-HAZARDOUS;

MISE EN GARDE

EXPLOSION DE DANGER - NE DÉBRANCHEZ PAS L'ÉQUIPEMENT À MOINS QUE LE POUVOIR A ÉTÉ ÉTEINTE OU L'ENVIRONNEMENT EST CLASSÉ NON DANGEREUX;

WARNING

EXPOSURE TO SOME CHEMICALS MAY DEGRADE THE SEALING PROPERTIES OF MATERIALS USED IN THE FOLLOWING DEVICES: HAMLIN ELECTRONICS RELAY, MODEL HE721A0500, ALLIED ELECTRONICS RELAY, MODEL JW2SN-DC12V, AND PANASONIC RELAY, MODEL DS2E-SL2-DC5V

MISE EN GARDE

L'EXPOSITION À CERTAINS PRODUITS CHIMIQUES PEUT-ÊTRE DÉGRADER LES PROPRIÉTÉS DE L'ÉTANCHÉITÉ DES MATÉRIAUX UTILISÉS DANS LES APPAREILS SUIVANTS : RELAIS ÉLECTRONIQUE LIN, MODÈLE HE721A0500, ALLIÉES ÉLECTRONIQUE, MODÈLE JW2SN-DC12V ET RELAIS DE PANASONIC, MODÈLE DS2E-SL2-DC5V
SUBSTITUTION DES ÉLÉMENTS SUIVANTS PEUT ALTÉRER

WARNING

SUBSTITUTION OF THE FOLLOWING COMPONENTS MAY IMPAIR SUITABILITY FOR DIVISION 2

MISE EN GARDE

LES QUALITÉS DE DIVISION 2

Reference Designation	Description	Type of Protection
K1, K2, or K3	Relay	Sealed Contacts

Warranty and Return Policy

SureFire Warranty Statement:

SureFire warrants all equipment of its own manufacture to be free of defects in material and workmanship. SureFire's sole obligation hereunder shall be expressly limited to repair or exchange, F.O.B. Farmington, NM, USA of such defective equipment, but does not apply to claims which are a result of improper installation, misuse, maladjustment, abnormal operating conditions, or lack of routine maintenance as determined by SureFire. Nor does the warranty include the furnishing of service for maintenance or problems arising from the foregoing causes. No claims for labor, installation, removal, transportation, or other expenses will be recognized. Notwithstanding any stipulation of the purchaser to the contrary, all other obligations, representations, warranties and conditions, express or implied, statutory or otherwise, including any implied warranties or conditions of merchantability, quality or fitness are hereby excluded and, SureFire shall not be liable for any loss, cost or damages, of any kind whatsoever, whether consequential, indirect, special or otherwise, arising out of or in connection with the equipment or any defect therein, even if caused by the negligence of SureFire, its employees or agents. The provisions hereof relating to the warranty and limitations hereon and limitation of liability shall continue to be enforceable between the parties notwithstanding termination of the within agreement for any reason including fundamental breach. Equipment not of SureFire manufacture shall pass through to the original manufacturer's or vendor's warranty.

Product Description	Warranty Policy Defective Products	Return Policy Customer Return New Product
SureFire Controllers: BMS-300, BMS-100, Flare-100 and BMS-350 Controllers	3 Years from date of purchase	180 Days from date of purchase 20% Minimum Restocking Fee
SureFire FT Ignition Units: FT-1, FT-2, FT-4, FT-6 and FTL-F Ignition Units	2 Years from date of purchase	180 Days from date of purchase 20% Minimum Restocking Fee
Additional Components	Manufacturers carry own individual warranty policy on Components.	Manufacturers carry own individual return policy on Components.

The warranty policy is related to manufacturing defects. The return policy is related to the return of product for any reason other than manufacturing defects. Returns must be approved by SureFire in advance of shipment and returned products must be in their original condition. Restocking fees for returns are at the discretion of SureFire and may vary by product.

Shipping Cost:

For Warranty Claims, the shipping cost incurred by shipping the product from the customer to SureFire will be at the expense of the customer. If the product is deemed under warranty by SureFire, then the shipping cost incurred by shipping the product from SureFire to the customer will be at the expense of SureFire. If the product is deemed non-warranty by SureFire, then the shipping cost incurred by shipping the product from SureFire to the customer will be at the expense of the customer.

For Return Claims, the shipping cost will be at the expense of the customer.

Warranty and Return Policy

Warranty Claims Resolution:

SureFire will provide one of the following resolutions for warranty claims. The resolution will be completed at the sole discretion of SureFire.

1. SureFire will repair any defective parts, free of charge to the customer.
2. SureFire will replace the defective product, free of charge to the customer.

SureFire will provide a credit, minus a restocking fee for approved return claims.

Voiding SureFire's Warranty:

SureFire's obligation under this warranty is limited to the above and does not apply to claims which are a result of improper installation, misuse, maladjustment, abnormal operating conditions, or lack of routine maintenance as determined by SureFire. Nor does the warranty include the furnishing of service for maintenance or problems arising from the foregoing causes.

Conducting product repairs, parts exchange or unauthorized maintenance will immediately void the SureFire warranty.

Non-Warranty Products:

In the event that a product is returned to SureFire under a warranty claim, and SureFire deems the product non-warranty, the following options are available on a case by case basis:

1. If the product is able to be repaired, SureFire may offer a quotation for the repair costs.
2. If the product is not able to be repaired, SureFire may either discard the damaged product or return the damaged product to the customer, upon customer consent.
3. A replacement product may be purchased.

Return Material Authorization:

To acquire a return material authorization from SureFire, it is highly recommended to contact the SureFire technical support hotline @ 505-333-2876 for potential troubleshooting.

If technical support deems that product in need of a warranty or returns claim, please contact the SureFire returns department @ 505-333-2878 Ext. 18 or @ returns@surefire-controls.com.

BMS-100 Description

Enclosure:

The SureFire BMS-100 system uses a polycarbonate NEMA 4X Enclosure to house the circuit board. The Graphic overlay, with membrane keypad is mounted on the exterior of the enclosure.



The NEMA 4X enclosure provides a high level of protection from harsh outdoor elements:

- ◆ Windblown Dust Protection
- ◆ Water Damage Protection - Rain, Sleet, Snow, Splashing and Direct Water Contact
- ◆ Corrosion Protection
- ◆ External Formation of Ice Protection

The Enclosure is IP66 certified and has been tested to the following to meet certifications:

- ◆ Dust tight, no ingress of dust; complete protection against contact
- ◆ Water projected in powerful water jets (12.5mm nozzle) against the enclosure from any direction shall have no harmful effects.

WARNING:

When drilling holes in the enclosure, ensure IP66 fittings are used to maintain the IP66 standard.
Failure to use IP66 standard fittings nullifies the IP66 certification.

BMS-100 Description

BMS-100 Circuit Board:

The SureFire BMS-100 System is controlled by state of the art, non-arcing, electronics that monitor and control all burner functions. It comes with 2 LED indicators and a LED display. It also comes with individual terminal blocks and power connector to ease wiring and installation.

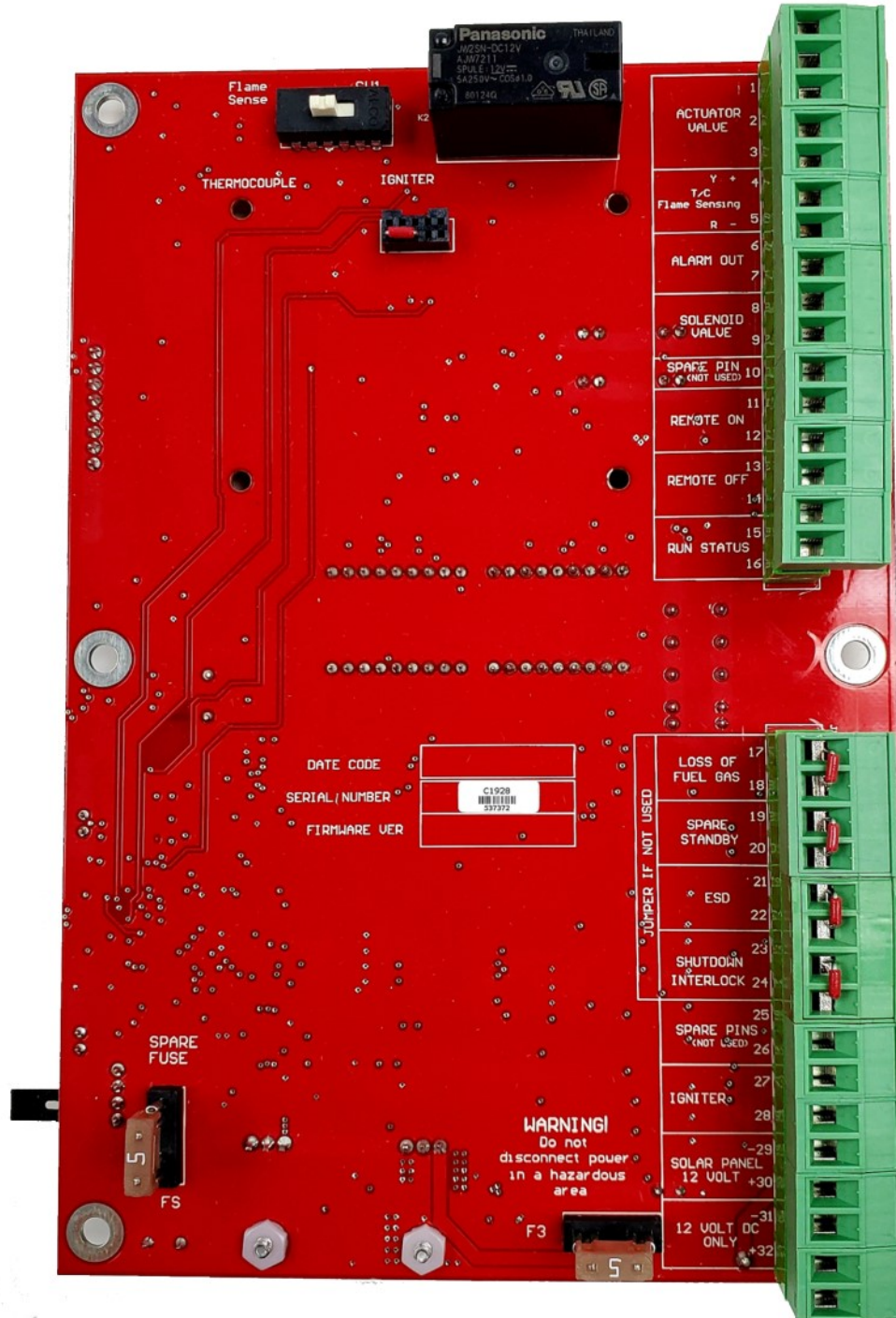

BMS-100 Description

LED Indicators:

The circuit boards LEDs illuminate through the lid of the enclosure. The LED's indicate the following:

LED Indicator	Status
GREEN	LED ON - Indicates that the system is on and operating properly
	Blinking - Indicates a standby switch has been activated
RED	LED ON - Indicates that the system is off
	Blinking - Indicates a shutdown switch has been activated

Graphic Overlay:

The overlay is used for interfacing with the system to acquire system data. The overlay also provides a list of status codes and a display window that shows data, settings and information.

SureFire  Made in USA

BMS-100

Status Codes:

Run Codes:

- 0 System Running
- 1 Purge Before Start up
- 4 5 Second Alarm
- 5 Igniter On

Standby Codes:

- 6 Spare Standby
- 7 Loss of Fuel Gas Standby
- 8 Flame Sense Countdown

For technical support,
contact SureFire @ 505-333-2876
www.SureFire-Controls.com

Shutdown Codes:

- 11 Manual / Remote Shut Off
- 12 Max Retries Exceeded
- 13 Low Battery Volts
- 14 Igniter Disconnected
- 15 Igniter Short
- 16 Shutdown Interlock
- 17 ESD Activated
- 18 Replace FT- Ignition Unit
- 19 T/C Flame Sensor Error or Disconnected
- 20 Solenoid Short
- 21 Solenoid Disconnected
- 22 Safety T/C High Temp. Shutdown
- 23 Safety T/C Error or Disconnected

Status Code

↑

Battery Volts

Flame Value

T/C HTS

OFF

ON

● **OFF / Shutdown**

Blinking = System in Shutdown - Check Status Code
Solid = System Manually Shutdown

● **ON / Standby**

Blinking = System in Standby - Check Status Code
Solid = System On

BMS-100 Description

5 Button Keypad:

The SureFire BMS-100 System has a 5 button Key Pad to control and monitor the system.

The buttons perform the following functions:

Button	Displayed Value / Functional Operation
On	<ul style="list-style-type: none"> ◆ Press once (<i>while in locked mode</i>) - Turns the system On ◆ Press once (<i>while in unlocked mode</i>) - Accepts new setpoint or setting selection within the menu system
Off	<ul style="list-style-type: none"> ◆ Press once (<i>while in locked mode</i>) - Turns the system Off ◆ Press and hold (<i>while in locked mode</i>) - Unlocks the system ◆ Press and hold (<i>while in unlocked mode</i>) - Lock the system
Status Code / Up Arrow	<ul style="list-style-type: none"> ◆ Press once (<i>while in locked mode</i>) - Displays the current system status code ◆ Press once (<i>while in unlocked mode</i>) - Increases the selected value
Battery Volts	<ul style="list-style-type: none"> ◆ Press once (<i>while in locked mode</i>) - Displays the current supply voltage to the BMS ◆ Press once (<i>while in unlocked mode</i>) - Enters the selected mode or selection to allow setting or setpoint adjustment
Flame Value / TC HTS	<ul style="list-style-type: none"> ◆ Press once (<i>while in locked mode</i>) - Displays current flame strength value of the ignition unit's flame sensing device ◆ Press and hold (<i>while in locked mode</i>) - Displays the current temperature value of the high temperature safety thermocouple ◆ Press once (<i>while in unlocked mode</i>) - Decreases the selected value

SureFire Ignition Units

SureFire FT-Series Ignition Units:

The SureFire BMS-100 is compatible with the listed FT series igniters. Each unit is designed for specific Flare, Combustor and Fire Tube applications. The FT series ignition units have been designed for both piloted and pilotless applications.

Flare / Combustor Pilot System:

The FTL-F series Ignition units are designed for Flare and Combustor applications, utilizing thermocouple as a flame sensor.

Piloted System:



The FT-1 Ignition units are designed for piloted applications, utilizing the igniter or thermocouple flame sensing device. The FT-1 Ignition units are used in a piloted application with burners ranging from 125,000 BTU/HR to 10 MM BTU/HR.

Optional Flame Sensors:

Thermocouple

- ◆ Utilizes temperature reading to verify the presence of a flame
- ◆ Armored wiring harness rated to 1000°F duty and 1500°F flash
- ◆ Direct termination to the BMS-100 Controller



For proper pilot placement and flame sensing selection, contact SureFire Tech Support @ 505-333-2876 or the local SureFire representative

SureFire Ignition Units

Pilotless System:

The FT-2, FT-4 and FT-6 Ignition units are designed for pilotless applications with a flame rod flame sensing device. These three ignition units are used in pilotless fire tube applications for horizontal treaters with the following BTU/HR burner ratings.

- ◆ FT-2 Systems (1") are rated for **125,000BTU/HR**
- ◆ FT-4 Systems (2") are rated for **500,000BTU/HR**
- ◆ FT-6 Systems (3") are rated for **1,000,000BTU/HR**

The FT-4-VT and FT-6-VT ignition units are designed for pilotless applications for vertical treaters and have the same BTU/HR burner ratings as above.

Thermocouple

- ◆ Utilizes temperature reading to verify the presence of a flame
- ◆ Armored wiring harness rated to 1000°F duty and 1500°F flash
- ◆ Direct termination to the BMS-100 Controller



For proper pilotless ignition unit and orifice sizing, contact tech support @ 505-333-2876 or the local SureFire representative

SureFire Additional Components



1" SureFire Actuator:

- ◆ Control the main fuel gas to the main burner.
- ◆ Factory programmed and pre-wired so no adjustment is necessary.
- ◆ 3 wire termination.
- ◆ Proof of valve closure switch kit available
- ◆ Applications include– non-venting pilotless fuel trains, double block fuel trains, fuel trains for combustors and flare systems.



1" & 2" SureFire Solenoid Valve:

- ◆ Fail-closed device.
- ◆ No adjustment necessary.
- ◆ Simple termination and installation.
- ◆ Kalrez elastomer plunger.
- ◆ Plunger replacement kits available.
- ◆ Applications include– non-venting pilotless fuel trains, double block fuel trains, fuel trains for combustors and flares systems.



SureFire Additional Components

1/4" ASCO Solenoid Valve:

- ◆ Fail closed device.
- ◆ No adjustment necessary.
- ◆ Simple termination and installation.
- ◆ Applications include— direct pilot (#72 orifice) and pneumatic valve operation.

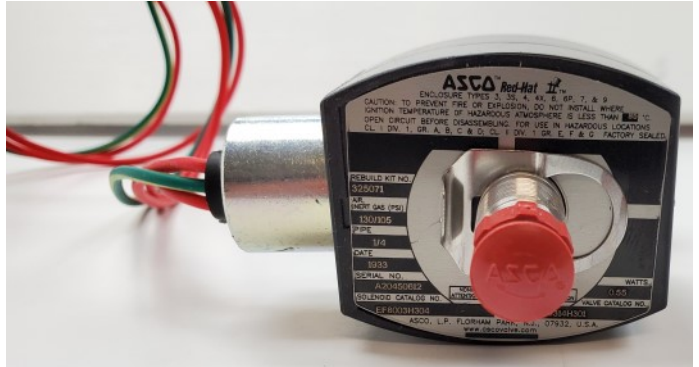

1/2" Pressure Switch:

- ◆ Used on a variety of standbys and shutdowns
- ◆ Can be set as normally open or normally closed.
- ◆ Adjustable from 1 psi — 15 psi.
- ◆ 316 SS construction, wetted parts are NACE



Thermocouple, Type K:

- ◆ Detects the process temperature.
- ◆ Simple two wire termination.
- ◆ Available in: 6", 9" and 12".



1/4" Slow Flow Valve:

- ◆ Reduces the inrush of fuel gas into the diaphragm valve for smooth and reliable ignition.
- ◆ Required on all pilotless installations when not using an actuator valve.
- ◆ Recommended for piloted installations



Installation Guide

SureFire BMS-100 Enclosure:

1. The enclosure is to be mounted on to a pole or a building that is capable of supporting 10 lbs.
2. Position the enclosure so that the LED display is clearly visible for the operator.
3. Install conduit seal-off fittings for all electrical connections to the enclosure.
4. Installation must comply with the national electric code.

WARNING:

- ◆ Before any welding is attempted, disconnect all wires going to the circuit board. Any damage caused by welding to the SureFire BMS is **NOT** covered under warranty.
- ◆ Before terminating any wires, be sure no power is supplied to the controller.
- ◆ Any damage caused by standing on or using the enclosure as a step is **NOT** covered under warranty.

SureFire FT-Series Ignition Unit:

1. Ensure supply gas is turned off and locked out / tagged out
2. Install the SureFire pilot ignition unit.
3. The igniter has two white wires that are not polarity sensitive, terminate wires to terminals (ports 27 & 28).
4. Thermocouple wires need to be terminated as described below.

Flame Sensing:

1. For thermocouple flame sensing terminate the red (-) wire at port 5 and the yellow (+) wire at port 4 (See Fig. 3) and position the switch on thermocouple.

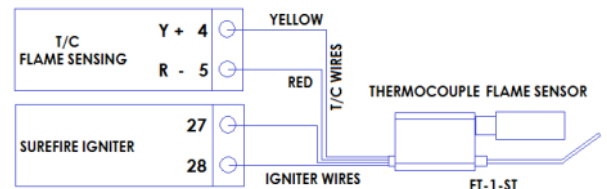

Warning:

The Flame Sensing Switch must be placed in proper position before power is applied to circuit board. Do not switch mode while circuit board is powered up.

Installation Guide

1st Stage Valve Control:

1. Ensure main supply gas is shut off.
2. Locate the pilot gas supply line.
3. Install a 1/4" ASCO or 1" SureFire solenoid valve in the appropriate location in the pilot fuel train.
4. Cut and bend custom 3/8" tubing and connect to tubing fittings on solenoid.
5. Terminate solenoid wires at the Solenoid Valve terminals port 8 & 9.

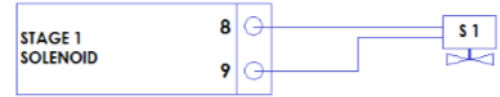

NOTES:

- ◆ ASCO Solenoid proper flow direction: 2 = Inlet and 1 = Outlet

2nd Stage Valve Control:

SureFire Actuator Valve:

1. Install a SureFire Actuator Valve in the fuel train on the main vent line to the combustor.
2. Terminate wires on terminal block labeled Actuator Valve (1, 2 & 3) from the Actuator Valve terminal ports (1, 2 & 3).

NOTES:

- ◆ SureFire Actuator 1 @ Terminal block 1
- ◆ SureFire Actuator 2 @ Terminal block 2
- ◆ SureFire Actuator 3 @ Terminal block 3
- ◆ Must use SureFire Actuator valve or an actuator approved by SureFire.

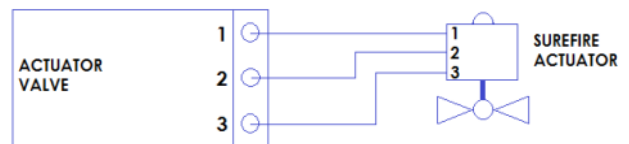

SureFire Solenoids:

1. Install a SureFire 1" or 2" Solenoid Valve in the fuel train on the main vent line to the combustor.
2. Terminate solenoid wires on ports 1 & 3 on Actuator Valve terminal block. Port 2 is not used.

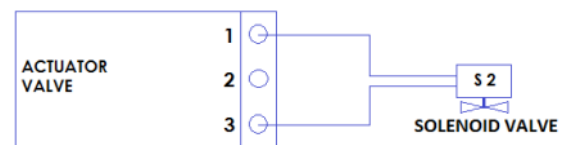

Installation Guide

Loss of Fuel Gas and Spare Standby:

1. If ports are not used, a jumper is required on ports 17 & 18 and 19 & 20.
2. When using a device, install a normally open or close dry contact device, terminate wires from device in one of the assigned terminals.

NOTES:

- ◆ Closed Contact = Normal Operation
- ◆ Open Contact = Failed Operation
- ◆ Standby does not require a local reset to re-start system.

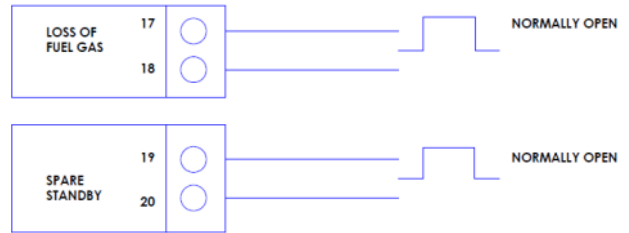

ESD and Shutdown Interlock:

1. If ports are not used, a jumper is required on ports 21 & 22 and 23 & 24.
2. When using a device, install a normally open or close dry contact device, terminate wires from device in one of the assigned terminals.

NOTES:

- ◆ Closed Contact = Normal Operation
- ◆ Open Contact = Failed Operation
- ◆ Shutdown requires a local reset to re-start system.

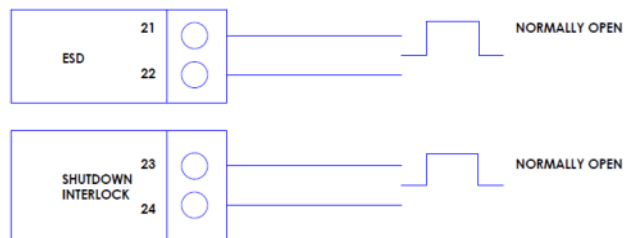

Alarm Out and Run Status:

The proper connection method for the Alarm Out and Run Status is as follow:

1. Terminate wires from the RTU/PLC to the Alarm out terminal (Ports 6 & 7).
2. Terminate wires from the RTU/PLC to the Run Status terminals (Ports 15 & 16).

NOTES:

- The above ports are left un-touched if not used.

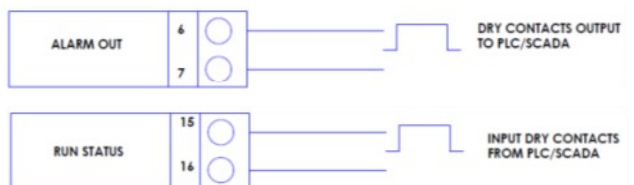

Installation Guide

Remote ON and Remote OFF

The proper connection method for the Remote ON or Remote OFF is as follows:

1. Terminate wires from the RTU/PLC to the Remote ON terminals (Ports 11 & 12).
2. Terminate wires from the RTU/PLC to the Remote OFF terminals (Ports 13 & 14).

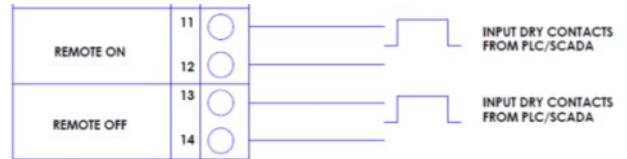

NOTES:

- ◆ The remote ON / OFF receives a signal from a momentary switch (closed loop) from the PLC/SCADA to turn unit ON or OFF remotely.
- ◆ During a Shutdown error, unit cannot be reset remotely using the Remote ON.

Solar Panel :

1. Install 12 VDC Solar Panel.
2. Connect negative (-) terminal to port 29.
3. Connect positive (+) terminal to port 30.

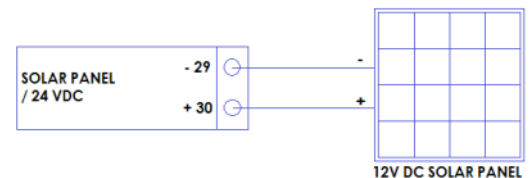

NOTES:

- ◆ Maximum rating for solar panel is 75 watts
- ◆ Circuit board has internal charge controller to charge 12 VDC battery, if a battery is connected to port 31 & 32

Battery

1. Install a 12VDC SLA battery within an enclosure separate of the SureFire enclosure.
2. Connect negative (-) terminal to port 31.
3. Connect positive (+) terminal to port 32.

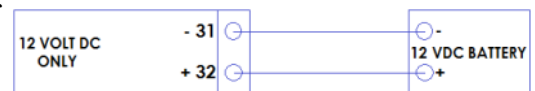

NOTES:

- ◆ If battery is more than 10 feet away from SureFire controller, use larger wire as needed.
- ◆ If utilizing 12 VDC power supply, set voltage @ 13.4 VDC. Power supply should be rated for 90 + watts.



Specifications

Power Supply Specifications

Battery Volts	12 - 13.4 VDC
12 VDC Power Supply	Set @ 13.4 VDC
Solar Panel	12 VDC / 75 W
Max System Amperage	5.0 Amp / 0.6 Amp Avg.

Ignition Unit Specifications

Ignition Unit @ Inrush	6.5 Amps
Ignition Unit @ Steady State	2.0 Amps Nominal (during ignition only)

Sensor Specifications

Standby and Shutdown Switches	Dry Contact Switch (Open / Close Loop)
Remote ON and Remote OFF	Dry Contact Switch (Open / Close Loop)

Battery / Igniter Wiring Requirements

16 AWG	10 foot length - Copper Stranded
14 AWG	20 foot length - Copper Stranded
12 AWG	30 foot length - Copper Stranded

Relay Specifications

Stage 1 Solenoid Valve Load	12 VDC, 60 Watt MAX
Actuator Valve Load	12 VDC, 60 Watt MAX

Other

Fuses: F3 and F5	10 Amps
------------------	---------

Run Status, Alarm Out and Flame Strength

Run Status and Alarm Out Operational States:

Unit Status	Run Status	Alarm Out	Green LED	Red LED
Manual OFF	Open	Open	OFF	ON
Shutdown	Open	Open	OFF	Blinking
Standby	Open	Closed	Blinking	OFF
Unit ON (Status Code 00)	Closed	Closed	ON	OFF

Flame Strength Value Information:

Thermocouple	No Flame Present	Flame Present
Open Flare Thermocouple Value	< 300°F	> 350°F
Combustor Thermocouple Value	20% Decrease (If value < 800°F) or 40% Decrease (If Value > 800°F)	Increase of 20°F

Wiring Diagram

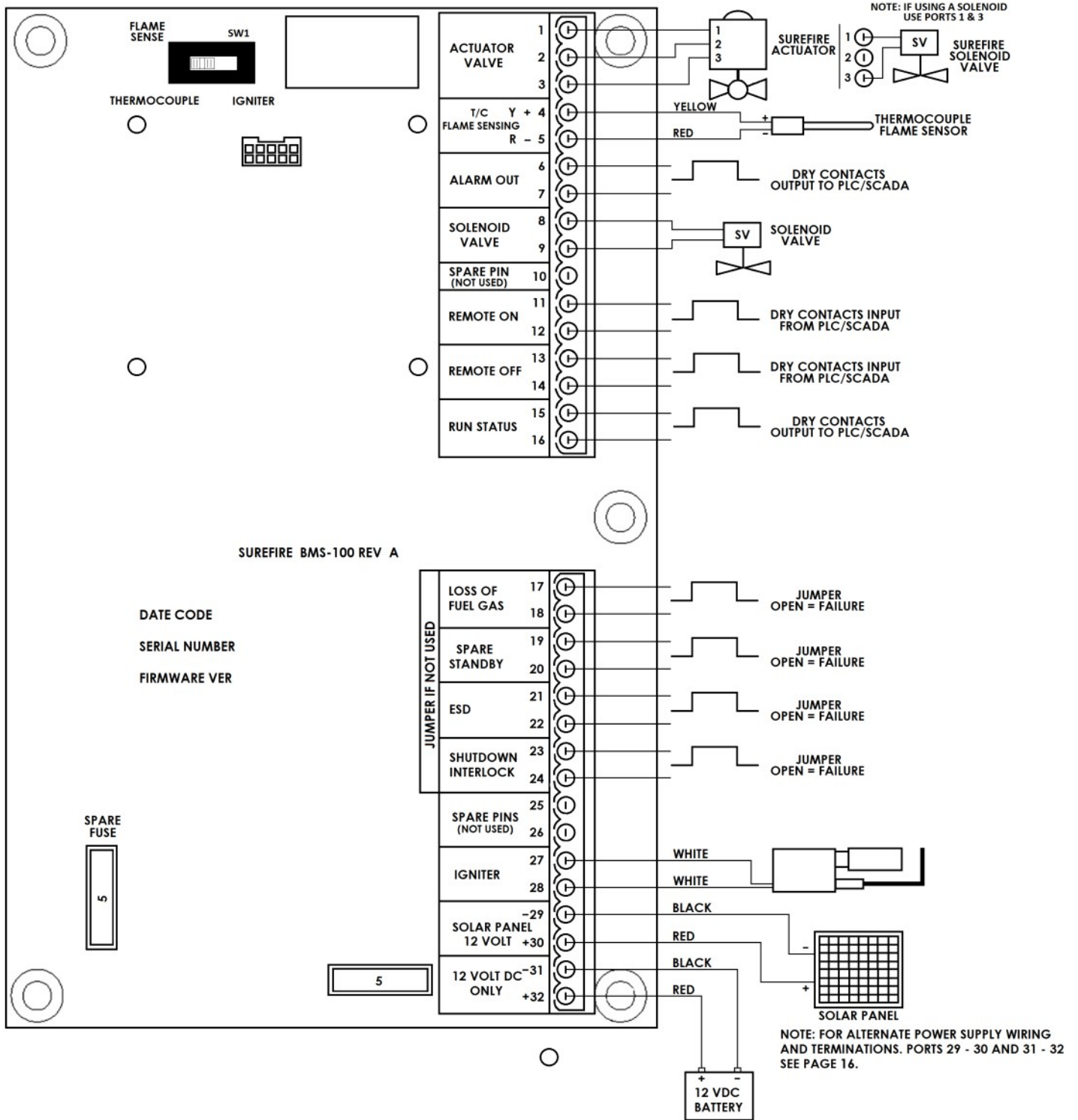

1" Solenoid Fuel Train Diagram

1" SureFire Solenoid Fuel Train

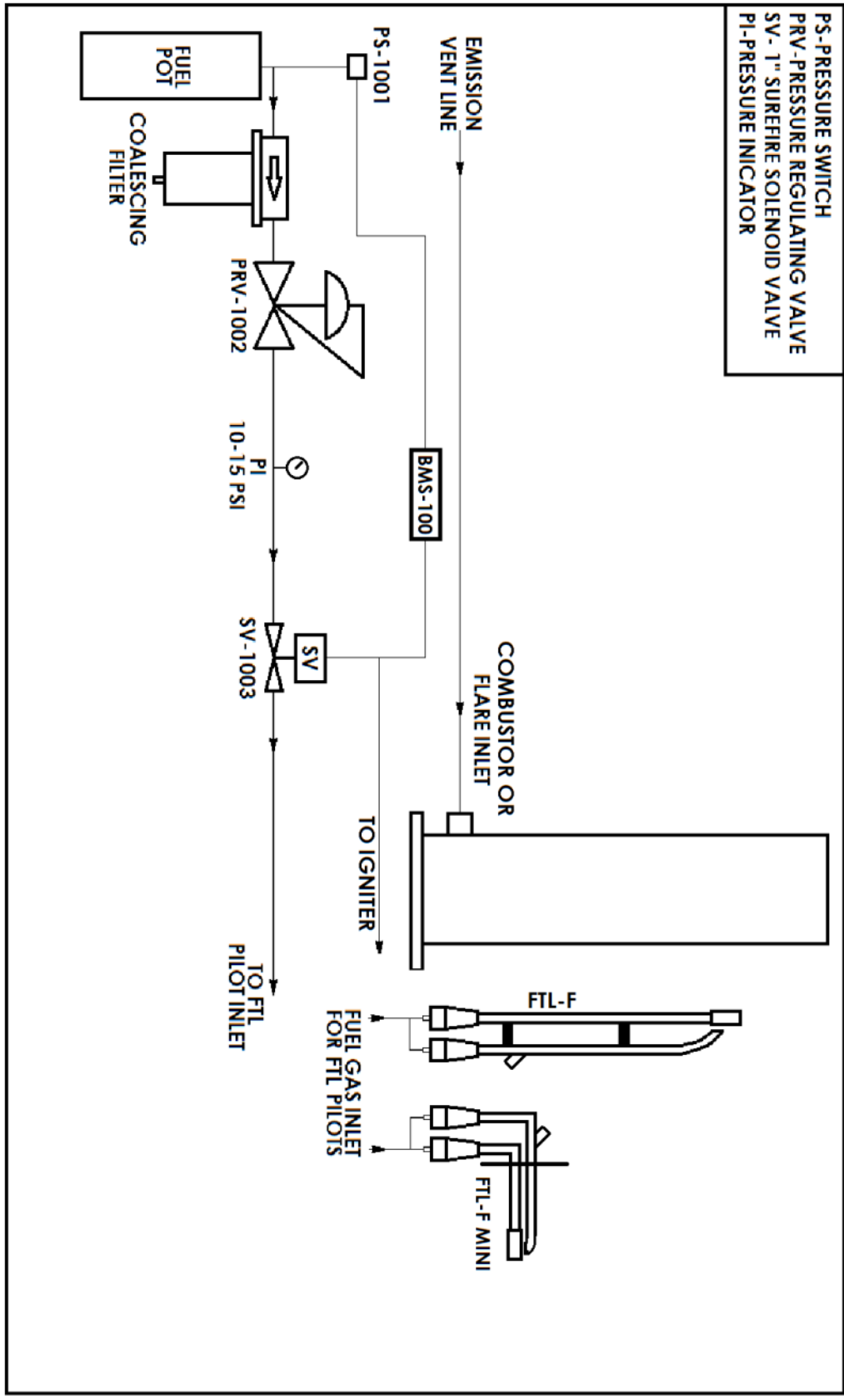

1" Solenoid & Actuator Valve Fuel Train Diagram

1" SureFire Solenoid / Actuator Fuel Train

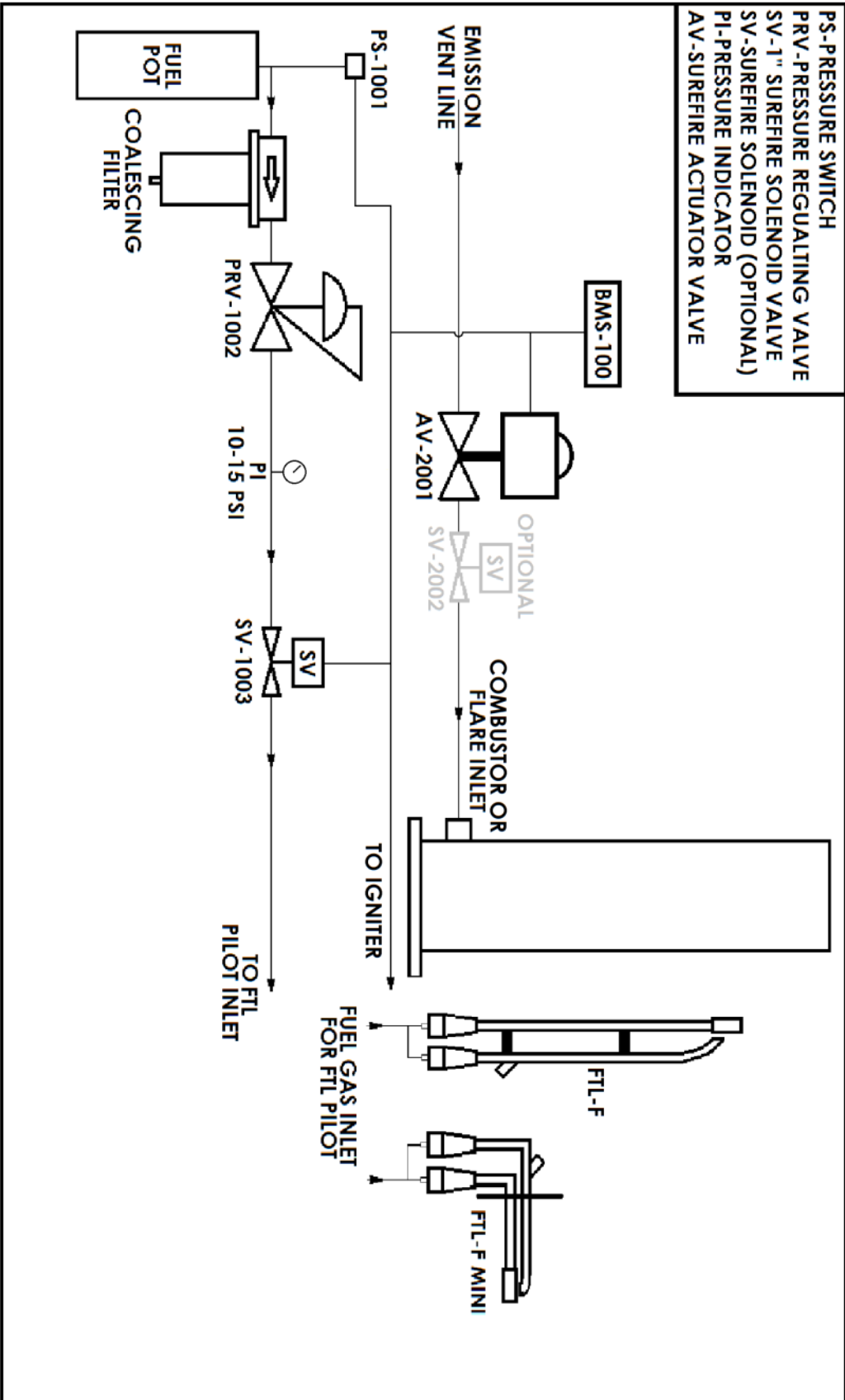

Asco, 3PG & Actuator Fuel Train Diagram

1/4" ASCO Solenoid / 3PG Valve / Actuator Fuel Train

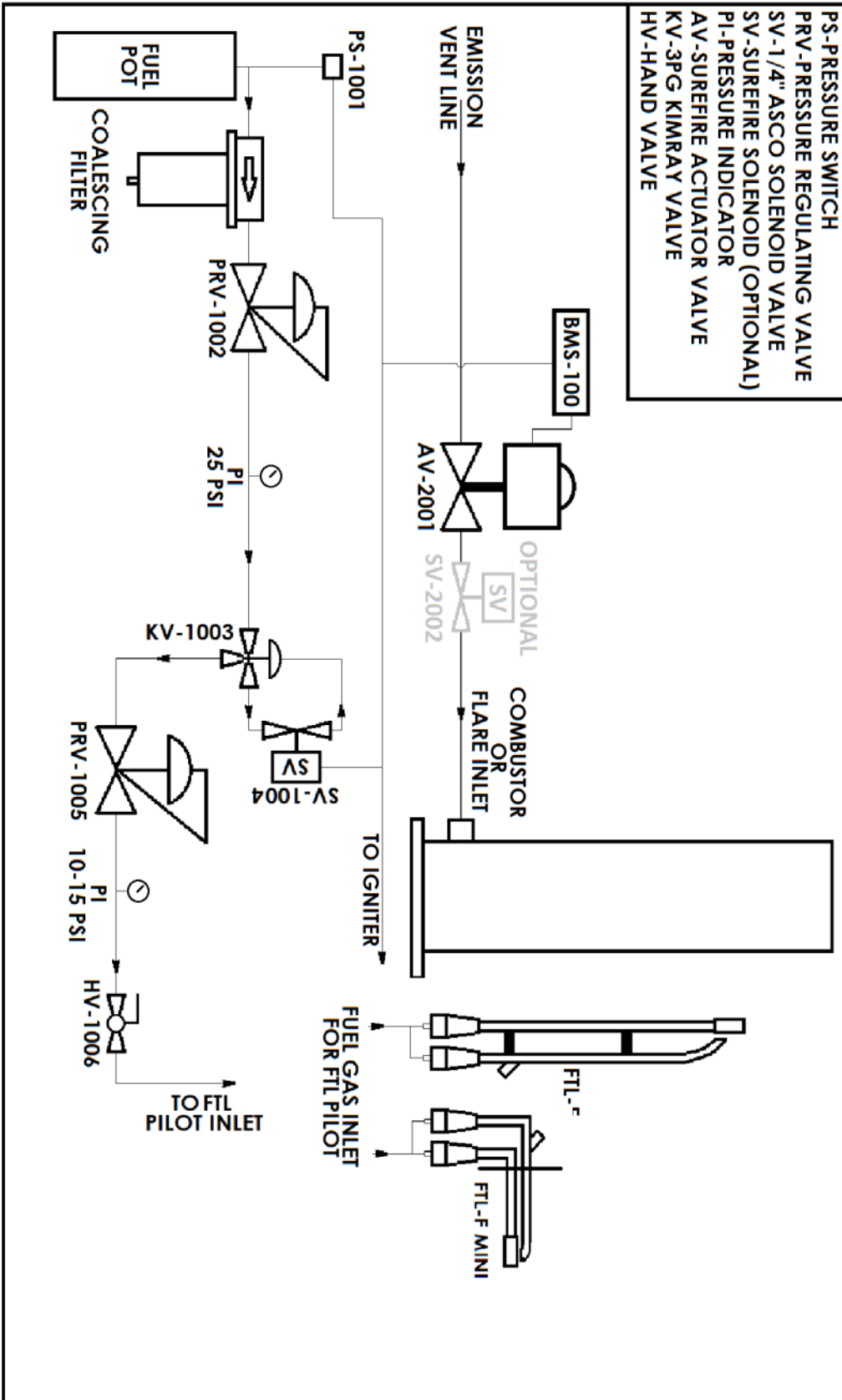

BMS-100 Setup / Menu

Menu Access

1. Press and hold the **OFF** button to unlock the system.
2. The display will show **0000** to indicate the system is unlocked.
3. The display will flash **OFF**.
4. The **Battery Volts** button is pressed to open or enter the menu.
5. The **Status Code / Up Arrow** button is used to increase the displayed selection.
6. The **Flame Value / TC HTS** button is used to decrease the displayed selection.
7. The **ON** button is pressed to accept the newly selected value and return to menu.
8. Press and hold the **OFF** button to lock the system.

NOTE:

The system must be locked in order to turn the system on and run through a sequence.

Flame Sensing Type - S-01

The first mode in the menu is the flame sensing type. This selection will determine how the flame sensing thermocouple detects the presence of ignition, as well as how the flame sensing thermocouple detects flame loss.

0 = Open Flare Flame Sensing Mode for Flare Applications

1 = Combustor Flame Sensing Mode for Combustor Applications

Default = 0 Open Flare

Max Retry Setpoint - S-02

The second mode in the menu is the maximum unsuccessful retries allowed prior to shutting down (Code 12).

Range = 1 attempt - 9,999 attempts

Default = 3

BMS-100 Setup / Menu

Pre-Purge Timing - S-03

The third mode in the menu is the pre-purge timing. This selection is the timing allotted prior to ignition (both initial startup and between ignition attempts) allowing raw combustible gas for safety purposes.

Range = 1 minute - 10 minutes

Default = 3 minutes

Safety Thermocouple Threshold - S-04

The fourth mode in this menu is the safety thermocouple threshold . This selection is the threshold in which the high temperature safety thermocouple's value must increase above to detect a high temperature shutdown (code 23).

Range = 100°F - 2,450°F

Default = 1,900°F

NOTE:

The Combination Adder Card must be installed to utilize this particular function

Pressure Low End Setpoint - S-05

The fifth mode in this menu is the pressure low end setpoint. This setpoint is the ounce / pressure setpoint that will determine at what input pressure the actuator valve or main valve will close.

Range = .5 ounces - 4 ounces

Default = 1 ounce

NOTE:

The Combination Adder Card must be installed to utilize this particular function

NOTE:

Modes S-07, S-08 and S-09 are functionally connected to S-06

BMS-100 Setup / Menu

Pressure High End Setpoint - S-06

The sixth mode in this menu is the pressure low end setpoint. This setpoint is the ounce / pressure setpoint that will determine at what input pressure the actuator valve or main valve will open.

Range = 2 ounces - 9 ounces

Default = 4 ounces

NOTE:

The Combination Adder Card must be installed to utilize this particular function

NOTE:

Modes S-06, S-08 and S-09 are functionally connected to S-07

Pressure Transmitter Scaling - S-07

The seventh mode in this menu is the 4-20mA scaling associated with the utilized pressure transmitter. Pressure transmitters will provide a 4-20mA signal based on a inH20 or ounce value. This selection allows for multiple pressure transmitter scaling types to be available.

0 = 0 - 50 inH20 Transmitter Type

1 = 0 - 100 inH20 Transmitter Type

NOTE:

The Combination Adder Card must be installed to utilize this particular function

NOTE:

If the utilized transmitter doesn't match the selected transmitter, the scaling and selections of S-05 and S-06 will not be accurate.

NOTE:

Modes S-06, S-07 and S-09 are functionally connected to S-08

BMS-100 Setup / Menu

Actuator Operation - S-08

The eighth mode within the menu determines the actuator valve's functionality or signal in which the actuator valve will open and / or close.

0 = Actuator opens and closed based on 4-20mA signal

NOTE:

If 0 is the selection of S-08, then mode S-06 and S-07 determines the pressure setpoint in which the actuator will open and close.

1 = Actuator opens 30 seconds after the stage 1 solenoid valve

Adder Card Operation - S-09

The ninth mode within the menu determines whether the BMS-100 is functioning with or without an adder card.

0 = No adder card included in the setup / operation

1 = An adder card has been included in the setup / operation

Modbus Address Information - S-10

The tenth mode within the menu determines the Modbus Address information when tying multiple Combination Cards Modbus function into the same PLC device.

The numerical value determines the device address or ID.

i.e.

1 equals device # 1

2 equals device # 2, etc.

BMS-100 Setup / Menu

Data Logging - S-11 thru S-15

The eleventh thru fifteenth modes allow the date and time to be setup for the data logging function.

S-11 sets the minute:

i.e. 15 = xx:15

S-12 sets the hour:

i.e. 4 = 4:xx

S-13 sets the day:

i.e. 6 = 6th day of the month.

S-14 sets the month:

i.e. 12 = December

S-15 sets the year:

i.e. 2024 = 2024

These values set the date and time in which the data logging will begin.

Sequence of Operation

Ignition Process:

1. Press the ON Button
2. Pre-purge - 180 second countdown displayed. **Green LED ON.**
3. Audible Alarm - 5 second countdown displayed. **Green LED ON.**
4. Igniter ON - 8 second countdown displayed. **Green LED ON.**
5. Solenoid valve opens - Igniter remains on for another 5 seconds. **Green LED ON.**
6. Ignition is achieved and a 30 second flame proof timing begins. Pilot ignites. **Green LED ON.**
7. Flame is sensed, flame proof timing countdown expires, the display reads ON. **Green LED ON.**
8. 30 second timer begins before actuator valve opens (hidden count down). **Green LED ON.**
9. After 30 seconds the actuator valve opens. **Green LED ON.**

Re-Ignition Process - Flame Out:

1. Once the system recognizes flame is not sensed, the system will automatically begin the re-ignition process. **Green LED ON.**
2. Reference step 2 - 7 in the “Ignition Process Section”.

Re-Ignition Process - Standby:

1. System in standby (contact open). **Green LED BLINKING.**
2. Once the Standby issue is resolved (contact close), the system will automatically begin the re-ignition process. **Green LED ON.**
3. Reference step 2- 7 in the “Ignition Process Section”

Re-Ignition Process - Shutdown:

1. The System requires manual reset in the event of a shutdown
2. System in shutdown. (contact open). **Red LED BLINKING**
3. Once the Shutdown issue is resolved (contact close), press the OFF button then ON button to reset. **Green LED ON.**
4. Reference step 2 - 7 in the “Ignition Process Section”

Sequence of Operation without Adder Card

Flow Chart:

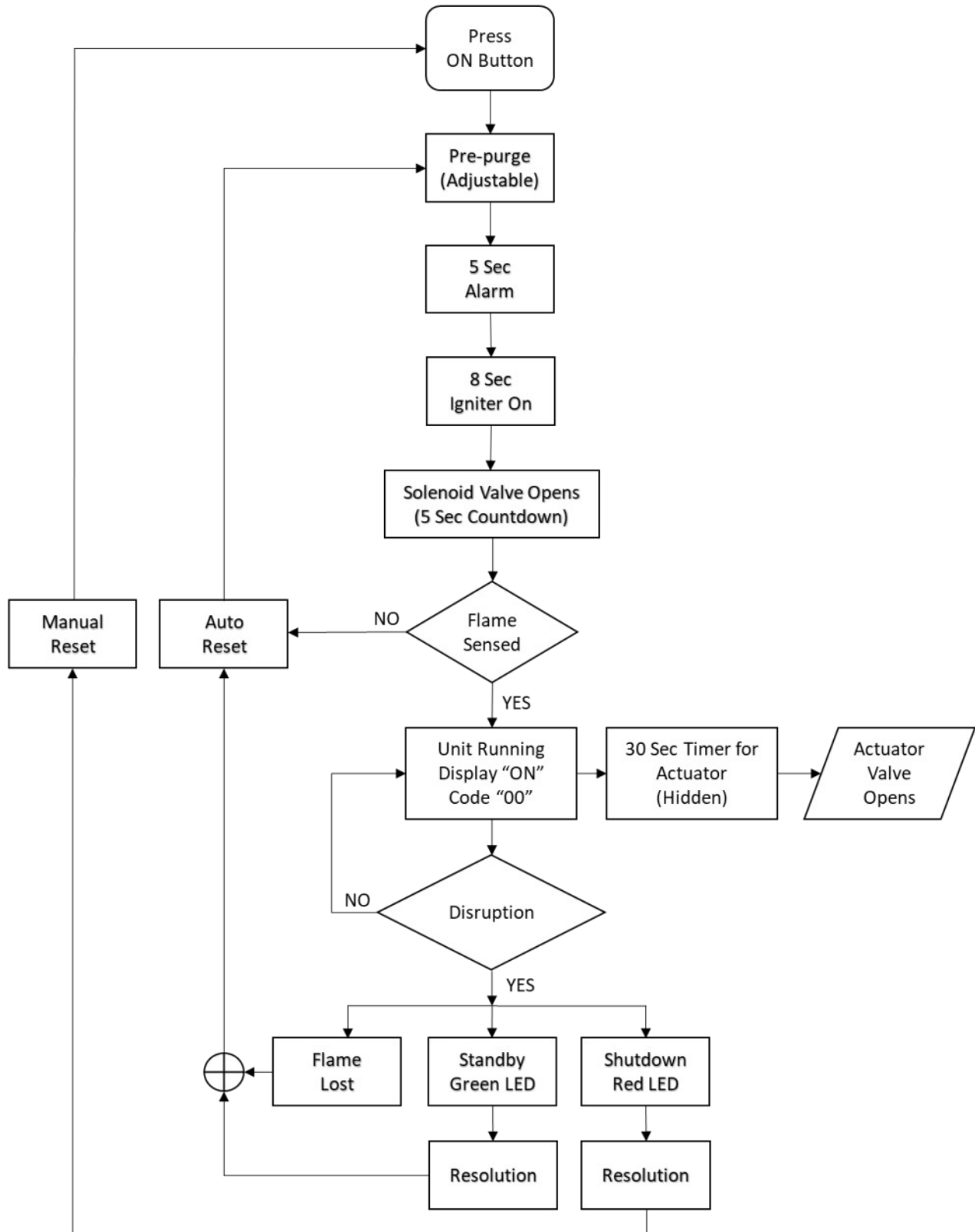

Sequence of Operation with Adder Card

Ignition Process:

1. Press the ON Button
2. Pre-purge - Pre-purge countdown displayed. **Green LED ON.**
3. Audible Alarm - 5 second countdown displayed. **Green LED ON.**
4. Igniter - 8 second countdown displayed. **Green LED ON.**
5. Solenoid valve opens - Igniter remains on for another 5 seconds. **Green LED ON.**
6. Ignition is achieved and a 30 second flame proof timing begins. Pilot ignites. **Green LED ON.**
7. Flame is sensed, flame proof timing countdown expires, the display reads “T/C temperature” (Status code 00). **Green LED ON.**
8. 4-20mA pressure input is observed on the display and monitored. **Green LED ON.**
9. Actuator valve opens and closes according to 4-20mA pressure input. **Green LED ON.**

Re-Ignition Process - Flame Out:

1. Once the system recognizes flame is not sensed, the system will automatically begin the re-ignition process. **Green LED ON.**
2. Reference step 2 - 7 in the “Ignition Process Section”

Re-Ignition Process - Standby:

1. System in standby (contact open). **Green LED BLINKING**
2. Once the Standby issue is resolved (contact close), the system will automatically begin the re-ignition process
3. Reference step 2- 7 in the “Ignition Process Section”

Re-Ignition Process - Shutdown:

- 1) The System requires manual reset in the event of a shutdown
- 2) System in shutdown (contact open). **Red LED BLINKING**
- 3) Once the Shutdown issue is resolved (contact close), press the OFF button then ON button to reset.
- 4) Reference step 2 - 7 in the “Ignition Process Section”

Sequence of Operation with Daughter Board-Features

Flow Chart:

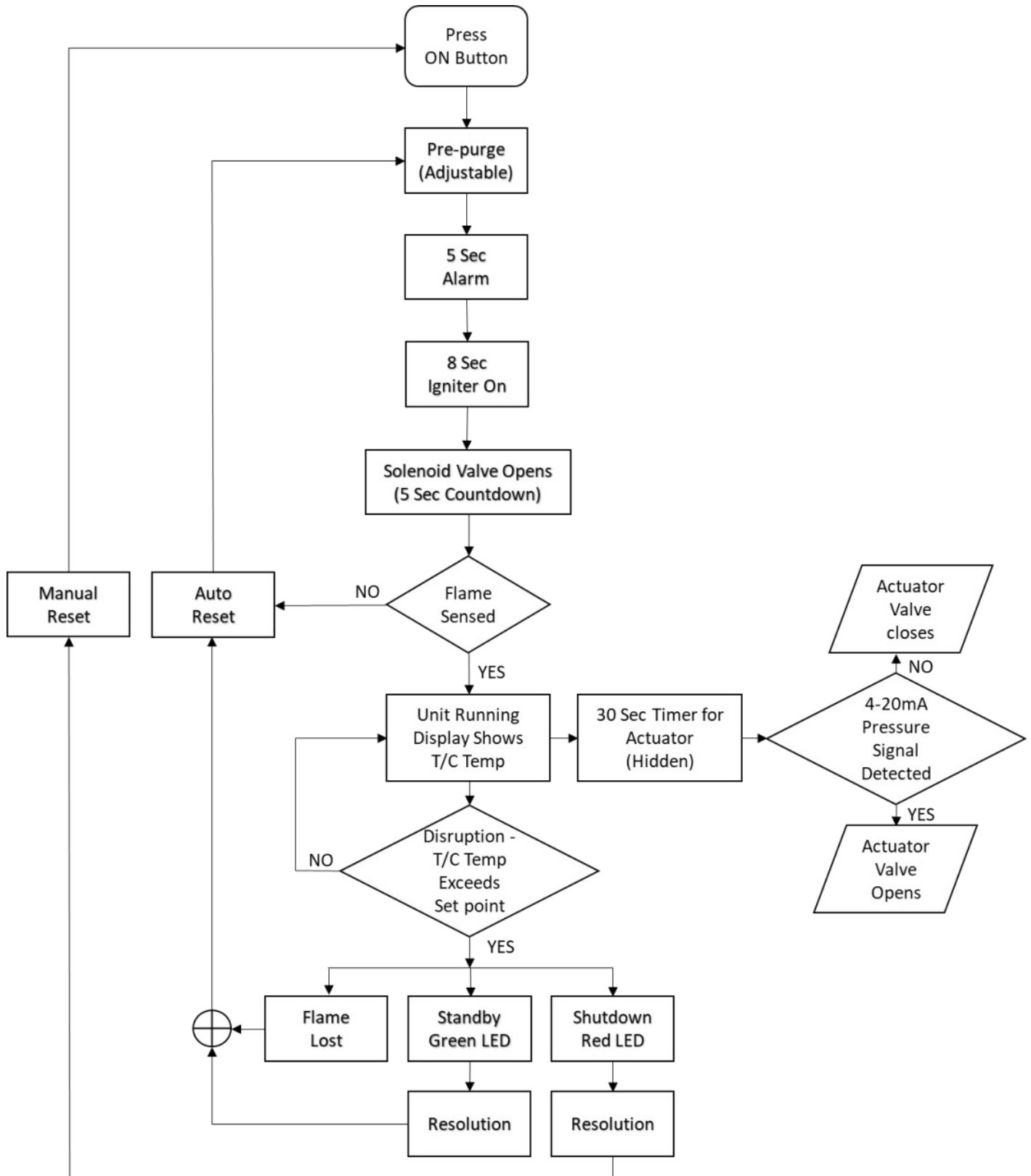

Troubleshooting Guide

Run Codes:

Code	Symptom	Action	LED
00 System Running	<ul style="list-style-type: none"> ◆ Pilot flame is present ◆ No errors 	<ul style="list-style-type: none"> ◆ Normal Operation ◆ Display reads On or Flame sensing thermocouple temperature value 	Green LED ON
01 Purge Before Start-up	<ul style="list-style-type: none"> ◆ Pilot flame not present 	<ul style="list-style-type: none"> ◆ Normal Operation ◆ Pre-purge countdown is displayed, adjustable between 1-10 minutes. 	Green LED ON
04 5 Second Alarm	<ul style="list-style-type: none"> ◆ Pilot flame not present 	<ul style="list-style-type: none"> ◆ System is warning operator on ignition attempt ◆ Ignition warning buzzer can be heard (120dB) 	Green LED ON
05 Igniter On	<ul style="list-style-type: none"> ◆ Pilot flame not present 	<ul style="list-style-type: none"> ◆ Igniter element is receiving voltage ◆ 8 second countdown ◆ Igniter element temperature is increasing 	Green LED ON

Standby Codes:

06 Spare Standby	<ul style="list-style-type: none"> ◆ Pilot flame not present ◆ No activity when attempting start-up ◆ Ports 19&20 are activated 	<ul style="list-style-type: none"> ◆ System detecting an open circuit ◆ Jumper is not installed ◆ Ports require a jumper when not used ◆ Normally open/close switch is activated ◆ Switching device is faulty ◆ Wiring from switching device is disconnected 	Blinking Green LED
07 Loss of Fuel Gas Standby	<ul style="list-style-type: none"> ◆ Pilot flame not present ◆ No activity when attempting start-up ◆ Ports 17&18 are activated 	<ul style="list-style-type: none"> ◆ System detecting an open circuit ◆ Jumper is not installed ◆ Ports require a jumper when not used ◆ Normally open/close switch is activated ◆ Switching device is faulty ◆ Wiring from switching device is disconnected 	Blinking Green LED
08 Flame Sense Countdown	<ul style="list-style-type: none"> ◆ Pilot flame present 	<ul style="list-style-type: none"> ◆ Normal Operation ◆ 30 second countdown is displayed ◆ System searching for pilot flame 	Green LED ON

Troubleshooting Guide

Shutdown Codes:

Code	Symptom	Action	LED
11 Manual/Remote	<ul style="list-style-type: none"> ◆ Pilot flame not present 	<ul style="list-style-type: none"> ◆ System turned off Manually or remotely (Ports 15&16 received a remote signal) ◆ Display shows OFF ◆ To restart system press the ON button 	Red LED ON
12 Max Retries Exceeded	<ul style="list-style-type: none"> ◆ Pilot flame not present ◆ No activity when attempting to start up 	<ul style="list-style-type: none"> ◆ Check fuel supply pressure ◆ Check power supply ◆ Check pilot pressure ◆ Verify Air/fuel ratio ◆ Flame cell partially plugged ◆ Verify solenoids and diaphragm valve are actuating ◆ Check for plugged or frozen orifices ◆ Vents plugged on solenoid or diaphragm valve ◆ Check ignition unit positioning ◆ Check Ohms on igniter 	Blinking Red LED
13 Low Battery Voltage	<ul style="list-style-type: none"> ◆ Pilot flame not present ◆ No activity when attempting to start up 	<ul style="list-style-type: none"> ◆ Check battery or power supply ◆ Replace battery or power supply ◆ Check solar panel or re-charging device ◆ A power outage occurred 	Blinking Red LED
14 Igniter Disconnected	<ul style="list-style-type: none"> ◆ Pilot flame not present ◆ System will proceed through startup but will shutdown when igniter receives voltage 	<ul style="list-style-type: none"> ◆ Ensure igniter wires are terminated properly ◆ Check for disconnected wires ◆ Igniter element could have wore out or is broken. ◆ Check power supply. When power supply is inefficient, system detects an open circuit 	Blinking Red LED
15 Igniter Short	<ul style="list-style-type: none"> ◆ Pilot flame not present ◆ System will proceed through startup but will shutdown when igniter receives voltage 	<ul style="list-style-type: none"> ◆ Ensure igniter wires are not touching each other or grounding to conduit. ◆ Ensure there is no moisture in the conduit. ◆ Check power supply. When power supply is inefficient, system detects a short circuit . 	Blinking Red LED

Troubleshooting Guide

Shutdown Codes:

Code	Symptom	Action	LED
16 Shutdown Interlock	<ul style="list-style-type: none"> ◆ Pilot flame not present ◆ No activity when attempting start-up ◆ Ports 21&22 are activated 	<ul style="list-style-type: none"> ◆ System detecting an open circuit ◆ Jumper is not installed ◆ Ports require a jumper when not used ◆ Normally open/close switch is activated ◆ Switching device is faulty ◆ Wiring from switching device is disconnected 	Blinking Red LED
17 ESD Activated	<ul style="list-style-type: none"> ◆ Pilot flame not present ◆ No activity when attempting start-up ◆ Ports 23&24 are activated 	<ul style="list-style-type: none"> ◆ System detecting an open circuit ◆ Jumper is not installed ◆ Ports require a jumper when not used ◆ Normally open/close switch is activated ◆ Switching device is faulty ◆ Wiring from switching device is disconnected 	Blinking Red LED
18 Replace FT-Ignition Unit	<ul style="list-style-type: none"> ◆ Pilot flame not present ◆ No activity when attempting start-up 	<ul style="list-style-type: none"> ◆ Igniter element has deteriorated - shows high ohms ◆ Igniter not getting up to temperature to ignite fuel gas 	Blinking Red LED
19 T/C Flame Sensor Error or Disconnected	<ul style="list-style-type: none"> ◆ Pilot flame not present ◆ No activity when attempting start-up 	<ul style="list-style-type: none"> ◆ Thermocouple faulty ◆ Polarity is reversed, verify wiring ◆ System detecting a disconnect upon initial start-up. ◆ Ensure proper flame sensing mode has been selected. 	Blinking Red LED
20 Solenoid Disconnected	<ul style="list-style-type: none"> ◆ Pilot flame not present ◆ No activity when attempting start-up 	<ul style="list-style-type: none"> ◆ System detecting a disconnect. ◆ Check device for faulty coil. ◆ Verify wiring from device. 	Blinking Red LED

Troubleshooting Guide

Shutdown Codes:

Code	Symptom	Action	LED
21 Solenoid Short	<ul style="list-style-type: none"> ◆ Pilot flame not present ◆ No activity when attempting start-up 	<ul style="list-style-type: none"> ◆ Solenoid wires are making contact with one another. ◆ Solenoid wires are making contact with ground 	Blinking Red LED
22 Safety T/C High Temp. Shutdown	<ul style="list-style-type: none"> ◆ Pilot flame not present ◆ No activity when attempting start-up 	<ul style="list-style-type: none"> ◆ High temperature set point reached ◆ Thermocouple wires are disconnected ◆ Thermocouple faulty ◆ Polarity is reversed, verify wiring ◆ Jumper is not installed ◆ Ports require a jumper when not used 	Blinking Red LED
23 Safety T/C Error or Disconnected	<ul style="list-style-type: none"> ◆ Pilot flame not present ◆ No activity when attempting start-up 	<ul style="list-style-type: none"> ◆ Thermocouple wires are disconnected ◆ Thermocouple faulty ◆ Polarity is reversed, verify wiring ◆ Jumper is not installed ◆ Ports require a jumper when not used 	Blinking Red LED

Combination Card Information

Combination Adder Card

The SureFire Combination Adder Card includes Modbus Communications, High Temperature Safety Thermocouple, 4-20mA Input and Data Logging.

Modbus communication through RS-485 communication protocol. Please refer to the Modbus section of this manual for more complete details.

- ◆ The Amber LED with nomenclature reading **Modbus Online** indicates the BMS is communication with the PLC Master.
- ◆ *Note: If multiple cards are being “daisy chained” together, remove the jumper on the combination card from the specific unit that the PLC is tying directly into, and leave the jumper installed on the “daisy chained” units.*

High Temperature Safety Thermocouple, this port is compatible with a type K thermocouple.

The **4-20mA Input**, is compatible with a 0-50 inH0 transmitter or 0-100 inH20 transmitter.

Data logging is completed through a USB connection.

- ◆ The Amber LED with nomenclature reading **Logging Data** indicates the BMS is logging data onto a USB.
- ◆ The Green LED with nomenclature reading **Remove USB on Green LED** indicates the **Press to eject USB safely** button has been pressed and the USB can now be removed.

Caution:

If the USB is removed prior to the Green LED illuminating, the data recorded within the USB may become corrupted.



Modbus Information

Programming Information for SureFire BMS-100 with Modbus Interface

Modbus registers, their contents, command sequencing and examples of command execution over Modbus are described.

This document applies to Combination Card firmware version 1.3. In order to use Modbus with the BMS-100, the BMS-100 firmware needs to be version 3.6 or greater.

Introduction:

The Modbus interface to the BMS-100 is accomplished via an intermediary processor board, the BMS Combination Card. **The function of this board is to serve as a Modbus RTU slave**, handling requests from the Modbus master to read information and relay command data to the BMS-100 board.

The Combination Card behaves as a specialized “mailbox”; a set of Modbus holding registers is available in the Combination Card any of which can be read by either the BMS board or the Modbus master. This arrangement relieves the BMS board of the job of hosting the Modbus and relaxes many of the timing constraints that would overtax the limited hardware resources on the BMS board Micro Controller Unit (MCU).

A number of the registers are constantly updated by the BMS board with information such as temperatures, modes, output states, ignition attempts, and other important data. These should be treated as read-only by the Modbus master.

RS-485 is available for use by the Modbus master. The configuration DIP switch also sets the Modbus slave address or slave ID and the baud rate.

LEDs are present on the Modbus board to indicate processing of Modbus packets (from the Modbus side) and BMS-100 packets (from the BMS-100 side). The **LEDs illuminate when intact packets are received and are being processed**. Under normal operation the LED on the BMS side should show regular activity as it updates the holding registers on the Modbus board and queries for command data. The LED on the Modbus side will only show activity if the Modbus master is reading from the Modbus board.

Amber LED Indication:

There is one on the Combination Card that indicates communication between the SureFire and the PLC.

Modbus Online LED:

This LED indicates that the Combination Card is communicating and sending data packages from the BMS-100 and the PLC. This LED is labeled **Modbus Online**.

Modbus Information

Basic Read Operation:

Basic operation of the BMS-100 with Modbus is as follows:

For reading a register (or registers) the Modbus master sends a holding register read request to the BMS Modbus board using **Modbus Function 03** (see “MODBUS APPLICATION PROTOCOL SPECIFICATION V1.1b”, www.modbus.org for more detailed information about the Modbus protocol and functions). The Combination Card will respond with the contents of the requested registers. There are currently 256 registers defined (Modbus addresses 40001 thru 40256), but not all are used. Attempts to read registers outside that address space will return an error according to the Modbus protocol.

While the Combination Card is servicing a read request from the master, it is unable to service simultaneous read requests from the BMS board for command data. This may result in the BMS board waiting for access and may result in a blinking LED display on the BMS board. For this reason it is best for the master to refrain from reading a large number of registers in a single request, and also to avoid issuing rapid read requests. It is suggested that read requests be limited to about 10 registers or less at a time.

Note:

Address 40001 maps to Register 1
 Address 40002 maps to Register 2
 ↓ ↓ ↓

Address 40255 maps to Register 255

Modbus Address	Register Name Modbus Master	Data Type	Notes
40,001	Status Code (R)	Unsigned Int. 16	See Status Code on page 34 - 37 or reference the BMS-100 overlay
40,002	Flame Sense Thermocouple Valve (R)	Unsigned Int. 16	Bit 9...0 is 0°F - 2,400°F
40,003	Igniter Ohms Reading	Unsigned Int. 16	Bit 9...0 is 0 - 40 Igniter Value
40,004	Combination of all digital switches	Unsigned Int. 16	Single Bit Information
40,005	Battery Volts (R)	Unsigned Int. 16	Bit 9...0 is a Voltage Value
40,006	Flame Sense Type	Unsigned Int. 16	0 = Open Flare 1 = Combustor

Modbus Information

Modbus Address	Register Name Modbus Master	Data Type	Notes
40,007	Max Retry Value	Unsigned Int. 16	Bit 9...0 is 1 - 9,999 Attempts
40,008	Pre-Purge Timing Setpoint	Unsigned Int. 16	Bit 9...0 is 1 - 9 Minutes
40,009	Safety Thermocouple Threshold	Unsigned Int. 16	Bit 9...0 is 100°F - 2,400°F
40,010	Pressure Signal Low Setpoint	Unsigned Int. 16	Bit 9...0 is .5 oz - 4 oz
40,011	Pressure Signal High Setpoint	Unsigned Int. 16	Bit 9...0 is 2 oz - 9 oz
40,012	Pressure Signal Scale	Unsigned Int. 16	0 = 0 oz - 50 oz Transmitter 1 = 0 oz - 100 oz Transmitter
40,013	Pressure Signal Live Value	Unsigned Int. 16	Bit 9...0 is 0 oz - 57.8 oz
40,014	Safety Thermocouple Live Value	Unsigned Int. 16	Bit 9...0 is 0°F - 2,400°F
40,016	Loss of Fuel Gas	Unsigned Int. 16	0 = Not Active / Alarm Not Active 1 = Active / Alarm Active
40,017	Spare Standby	Unsigned Int. 16	0 = Not Active / Alarm Not Active 1 = Active / Alarm Active
40,018	ESD	Unsigned Int. 16	0 = Not Active / Alarm Not Active 1 = Active / Alarm Active
40,019	Shutdown Interlock	Unsigned Int. 16	0 = Not Active / Alarm Not Active 1 = Active / Alarm Active
40,020	Run Status	Unsigned Int. 16	0 = Active 1 = Not Active
40,021	Alarm Out	Unsigned Int. 16	0 = Not Active 1 = Active
40,023	Data Logging Minute	Unsigned Int. 16	Bit 9...0 is active data
40,024	Data Logging Hour	Unsigned Int. 16	Bit 9...0 is active data
40,025	Data Logging Day	Unsigned Int. 16	Bit 9...0 is active data
40,026	Data Logging Month	Unsigned Int. 16	Bit 9...0 is active data
40,027	Data Logging Year	Unsigned Int. 16	Bit 9...0 is active data

NOTE:

Ensure the receiving end, the following bit settings are set as follows:

Data Bit:	8	Parity Bit:	None
Stop Bit:	1	Baud Rate:	9,600

Modbus Troubleshooting

Symptom:

The LED on the Combination Card is not flashing.

Discussion:

The LED only flash when intact (complete and correct) packets are received from their respective interfaces. If the data arrives garbled, or if no data is sent, then the corresponding LED will not flash.

Possible Solutions:

1. Verify that the baud rate for data transmission is in agreement on both sides (for example, if the BMS Modbus board is set for 9600 baud, then the Modbus master must also be set for 9600 baud).
2. Verify that no more than 10 registers are being poled at a single time.
3. Reduce the frequency of register poling to less than once every two seconds.
4. Remove power from the BMS for 10 - 15 seconds, allowing all power to be discharged. Reapply power and restart process.



BMS-100 Installation and Operations Manual:

Last Update: November 29th, 2022

Version: 3.5

SureFire Farmington, NM Office:

Mailing Address: 1910 Rustic Place, Farmington, NM 87401

Phone: (505) 333 - 2878

SureFire Houston, TX Office:

Mailing Address: 12510 Cutton Road, Houston, TX 77066

Phone: (281) 377 - 9756

SureFire 24-Hour Technical Support:

Phone: (505) 333 - 2876

For SureFire Product Updates Please Visit:

www.surefire-controls.com

Follow Us:

